

Operating Instructions



Vitodens 100-W B1HA/B1KA

Models 26 to 125

Wall-Mounted, gas-fired condensing boilers

On demand domestic hot water with Combi boiler

Heating input: 21 to 125 MBH

6.2 to 36.6 kW



VITODENS® 100-W



WARNING

If the information in this manual is not followed exactly, a fire or explosion may result causing property damage, personal injury or loss of life.

Do not store or use gasoline or other flammable liquids in the vicinity of this or any other appliance.

WHAT TO DO IF YOU SMELL GAS

- Do not try to light any appliances.
- Do not touch any electrical switches, do not use any phone in your building.
- Immediately call your gas supplier from a neighbor's phone. Follow the gas supplier's instructions.
- If you cannot reach your gas supplier, call the fire department.

Installation and service must be performed by a qualified installer, service agency or the gas supplier.

WARNING

Improper installation, adjustment, and/or operation could cause carbon monoxide poisoning resulting in injury or loss of life.

This product must be installed and serviced by a professional service technician who is experienced and qualified in hot water boiler installation and gas combustion.



IMPORTANT

Read and save these instructions for future reference.

Safety, Installation and Warranty Requirements

Please ensure that these instructions are read and understood before commencing installation. Failure to comply with the instructions listed below and details printed in this manual can cause product/property damage, severe personal injury, and/or loss of life. Ensure all requirements below are understood and fulfilled (including detailed information found in manual subsections).

■ Product documentation

Read all applicable documentation before commencing installation. Store documentation near boiler in a readily accessible location for reference in the future by service personnel.

► For a listing of applicable literature, please see section entitled "Important Regulatory and Safety Requirements".



■ Warranty

Information contained in this and related product documentation must be read and followed. Failure to do so renders the warranty null and void.



■ Licensed professional heating contractor

The installation, adjustment, service and maintenance of this equipment must be performed by a licensed professional heating contractor.

► Please see section entitled "Important Regulatory and Installation Requirements".



■ Contaminated air

Air contaminated by chemicals can cause by-products in the combustion process, which are poisonous to inhabitants and destructive to Viessmann equipment.

► For a listing of chemicals which cannot be stored in or near the boiler room, please see subsection entitled "Combustion Air Supply".



■ Carbon monoxide

Improper installation, adjustment, service and/or maintenance can cause flue products to flow into living space. Flue products contain poisonous carbon monoxide gas.

► For information pertaining to the proper installation, adjustment, service and maintenance of this equipment to avoid formation of carbon monoxide, please see instructions supplied with burner.



■ Fresh air

This equipment requires fresh air for safe operation and must be installed ensuring provisions for adequate combustion and ventilation air exist.

► For information pertaining to the fresh air requirements of this product, please see subsection entitled "Combustion Air Supply".

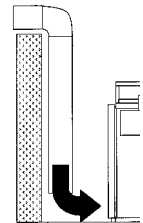

■ Equipment venting

Never operate boiler without an installed venting system. An improper venting system can cause carbon monoxide poisoning.

► For information pertaining to venting and chimney requirements, please see section entitled "Venting Connection". All products of combustion must be safely vented to the outdoors.



■ Advice to owner

Once the installation work is complete, the heating contractor must familiarize the system operator/ultimate owner with all equipment, as well as safety precautions/requirements, shutdown procedure, and the need for professional service annually before the heating season begins.

! WARNING

Installers must follow local regulations with respect to installation of carbon monoxide detectors. Follow manufacturer's maintenance schedule of the boiler contained in "Service Instructions" manual.

Safety, Installation and Warranty Requirements

Safety

Safety, Installation and Warranty Requirements..... 2

About these Instructions 4

For your Safety 4

 Operation 4

 Flue gas smell 4

 Working on the equipment 4

 Dangerous conditions 4

 Maintenance and cleaning 4

 Technical Information 4

 Carbon monoxide 5

 For safe operation 5

 Frozen water pipe hazard 6

 Installation area conditions 7

 Sources of combustion and ventilation air 7

 contaminants 7

 Energy saving tips 7

Start-up

Overview of Controls and Indicators 8

 Display indicators and operating buttons 8

 On-screen buttons for operation 8

 Default display 8

Operation

Operating Mode of the Heating System 9

Starting the Heating System 9

Shutting Down the Heating System 10

Stopping Central Heating and DHW Heating 10

Setting the Central Heating Temperature 11

Setting the Heating Curve 12

Adjusting the Heating Curve 12

Adjusting the Heating Curve Set Point 13

DHW Temperature 14

Troubleshooting

Rooms are too Cold 15

Rooms are too Hot 15

There is no Hot Water 16

DHW is too Hot 16

⚠ and Fault Code Flashes on the Display 16

⚠ is Shown on the Display 16

Fault Messages on the Display 17

Resetting a Burner Fault 17

Maintenance

Cleaning 18

Inspection and Maintenance 18

Information

Terminology 19

Lighting and Operating Instructions 20

Your Local Viessmann Experts:
Francis Plumbing & Heating ClimateCare
phone: 613-224-0041
email: office@francisplumbing.com
chat on our website: www.FrancisPlumbing.com

About these Instructions

 Take note of all symbols and notations intended to draw attention to potential hazards or important product information. These include “WARNING”, “CAUTION”, and “IMPORTANT”. See below.

WARNING

Indicates an imminently hazardous situation which, if not avoided, could result in death, serious injury or substantial product/property damage.

► Warnings draw your attention to the presence of potential hazards or important product information.

CAUTION

Indicates an imminently hazardous situation which, if not avoided, may result in minor injury or product/property damage.

► Cautions draw your attention to the presence of potential hazards or important product information.

IMPORTANT

► Helpful hints for installation, operation or maintenance which pertain to the product.



► This symbol indicates that additional, pertinent information is to be found.



► This symbol indicates that other instructions must be referenced.

For your Safety

■ Operation

Before operating the boiler, make sure you fully understand its method of operation. Your heating contractor should always perform the initial start-up and explain the system. Any warranty is null and void if these instructions are not followed.

■ Flue gas smell

- Deactivate heating equipment.
- Open windows and doors.
- Inform your heating contractor immediately.

■ Working on the equipment

All personnel working on the equipment or the heating system must have the **proper qualifications** and hold all necessary licenses.

Ensure **main power** to equipment, heating system, and all external controls have been **deactivated**. **Close main gas supply valve**. Take precautions in all instances to avoid accidental activation of power during service work.

■ Dangerous conditions

- Deactivate main power immediately.
- Close gas supply valve.

■ Maintenance and cleaning

Regular inspection and service by a qualified heating contractor is important to the performance of the Viessmann Vitodens 100-W. Neglected maintenance impacts on warranty; regular inspection ensures clean, environmentally friendly and efficient operation. We recommend a maintenance contract with a qualified heating contractor.

■ Technical information

- Technical Data Manual
- Installation and Service Instructions
- Operating Instructions and User's Information Manual
- Vitodens Venting System Installation Instructions
- Quick Start-up Guide
- Instructions of other products utilized and installed
- Installation codes mentioned in this manual

For your Safety *(continued)*

■ **Carbon monoxide**

The U.S. Consumer Product Safety Commission strongly recommends the installation of carbon monoxide detectors in buildings in which gas-burning equipment is installed. Carbon monoxide (CO) is a colorless, odorless gas, which may be produced during incomplete combustion of fuel and/or when the flame does not receive an adequate supply of combustion air.

Carbon monoxide can cause severe personal injury or loss of life.

Therefore, carbon monoxide detectors that are in compliance with a nationally recognized standard (e.g. ANSI/UL 2034, CSA 6.19 - latest editions) should be installed and maintained in buildings that contain gas-burning equipment.

Note: Viessmann does not test any detectors and makes no representation regarding any brand or type of detector.

■ **For safe operation**

We recommend that you frequently:

- Check for debris which could obstruct the flow of flue gases. The vent or chimney must not be blocked. A blocked or partially blocked vent or chimney can cause flue gases to leak into the structure. Flue gases leaking into the house can cause injury or death. A qualified heating contractor must remove the blockage from blocked or partially blocked chimneys.
- Check pressure gage for correct system (water) pressure. Check for water on the floor from the discharge pipe of the pressure relief valve or any other pipe, pipe joint, valve or air vent.
- Check for moisture, water, or appearance of rust on the flue gas pipes, their joints as well as vent dampers, or side wall vent terminals (if so equipped).
- Ensure that nothing is obstructing the flow of combustion and ventilation air and no chemicals, garbage, gasoline, combustible materials, flammable vapors and liquids are stored (not even temporarily) in the vicinity of the boiler.
- Do not allow unsupervised children near the boiler.

Service/inspection of the boiler and the system is recommended once per year. Maintenance, service and cleaning are specified in the Installation and Service Instructions.

Before the heating season begins, it is recommended that the boiler and burner be serviced by a qualified heating contractor. Service contracts may be established through gas suppliers or other licensed contractors in your area.

 **WARNING**

As there are no user-serviceable parts on the boiler, burner or control, the end-user must not perform service activities or adjustments of any kind on system components. Failure to heed this warning can cause property damage, severe personal injury, or loss of life.

 **WARNING**

Improper installation, adjustment, service, or maintenance can cause flue products to flow into living space. Flue products contain poisonous carbon monoxide gas which can cause nausea or asphyxiation resulting in severe personal injury or loss of life.

 **CAUTION**

Should overheating occur or the gas supply fail to shut off, do not disconnect the electrical supply to the pump. Instead, shut off the gas supply at a location external to the appliance.

 **WARNING**

The operator/ultimate owner is required to have the heating boiler, burners, and controls checked, as a minimum once per year, by the original installer or by a competent heating contractor familiar with the equipment. Defects must be corrected immediately.

 **CAUTION**

Do not use this boiler if any part has been under water. Immediately call a qualified heating contractor to inspect the boiler and to replace any part of the control system and any gas control which has been under water.

For your Safety *(continued)***Frozen water pipe hazard****! WARNING**

Failure to protect against frozen pipes could result in burst water pipes, serious property damage and/or personal injury. Boiler may shut down. Do not leave your home unattended for long periods of time during freezing weather conditions without turning off the water supply and draining water pipes or otherwise protecting against the risk of frozen pipes.

Your heating boiler is designed to provide a warm and comfortable living environment. It is NOT designed to ensure against freezing of water pipes. The boiler is equipped with several safety devices that are designed to shut down the boiler and to prevent it from restarting in the event of various unsafe conditions.

If your boiler remains off for an extended period of time during cold weather, water pipes may freeze and burst, resulting in extensive water damage and conditions in which mold could grow. Certain molds are known to cause respiratory problems, as well as to pose other serious health risks. In case of water damage, immediate measures should be taken to dry out affected areas as quickly as possible to prevent mold from developing.

If your home will be unattended for an extended period of time during cold weather, you should...

- Shut off the water supply to the building, drain the water pipes and add an antifreeze for potable water to drain traps and toilet tanks. Open faucets where appropriate.

Or...

- Have someone check the building frequently during cold weather and call a qualified service agency if required.

Or...

- Install a reliable remote temperature sensor that will notify somebody of freezing conditions within the home.

! WARNING

If you notice fire coming from the appliance, call the fire department immediately! Do not attempt to extinguish the fire unless qualified to do so.

! WARNING

Fire causes a risk of burns and explosion!

- Shut down the boiler
 - Close fuel shut-off valves
 - Use a tested fire extinguisher, class ABC.
- Ensure ambient temperatures are higher than 32°F (0°C) and lower than 104°F (40°C).
 - Prevent the air from becoming contaminated by halogenated hydrocarbons (e.g. as contained in paint solvents or cleaning fluids) and excessive dust (e.g. through grinding or polishing work). Combustion air for the heating process, and ventilation of the boiler room must be free of corrosive contaminants. To that end, any boiler must be installed in an area that has no chemical exposure. The list on page 7 indicates the main, currently known sources.
 - Avoid continuously high levels of humidity (e.g. through frequent drying of laundry).
 - Never close existing ventilation openings.

Replacement components, spare and wear parts**IMPORTANT**

Components which are not tested with the heating system may damage the heating system, or affect its functions. Installation or replacement may only be carried out by a qualified heating contractor.

Your Local Viessmann Experts:
Francis Plumbing & Heating ClimateCare
phone: 613-224-0041
email: office@francisplumbing.com
chat on our website: www.FrancisPlumbing.com

For your Safety *(continued)***Installation area conditions****WARNING**

Incorrect ambient conditions can lead to damage to the heating system and put safe operation at risk.

Sources of combustion and ventilation air contaminants.**Areas likely to contain contaminants:**

- New building construction
- Swimming pools
- Remodelling areas, hobby rooms
- Garages with workshops
- Furniture refinishing areas
- Dry cleaning/laundry areas and establishments
- Auto body shops
- Refrigeration repair shops
- Metal fabrication plants
- Plastic manufacturing plants
- Photo processing plants
- Beauty salons

Products containing contaminants:

- Chlorine-type bleaches, detergents and cleaning solvents found in household laundry rooms
- Paint and varnish removers
- Hydrochloric acid, muriatic acid
- Chlorine-based swimming pool chemicals
- Spray cans containing chlorofluorocarbons
- Chlorinated waxes and cleaners
- Cements and glues
- Refrigerant leaks
- Calcium chloride used for thawing
- Sodium chloride used for water softening salt
- Permanent wave solutions
- Adhesives used to fasten building products and other similar items
- Antistatic fabric softeners used in clothes dryers

Energy saving tips (central heating)

- **Room temperature:**
Never overheat your rooms. Every 2°F (1°C) of room temperature reduction saves up to 6% on your heating bills.
Never set your room temperature higher than 68°F (20°C).
- **Operating modes:**
If you do not require central heating, select one of the following operating modes:
 - In summer, if you do not want to heat any rooms but do need DHW, set the boiler water temperature to OFF (see page 10).
 - If you require neither room heating nor DHW for an extended period, set the boiler water temperature and the DHW temperature to OFF.
- **Ventilation:**
To ventilate, open windows fully briefly, and meanwhile close the thermostatic valves (if there is no mechanical ventilation system installed).
- **Roller shutters:**
Close roller shutters (where installed) at dusk.
- **Thermostatic valves:**
Ensure that thermostatic valves are properly adjusted.
- **Radiators:**
Never cover radiators or thermostatic valves.
- **DHW temperature:**
Never set the DHW tank temperature excessively high (see page 14).
- **Hot water consumption:**
Consider showering instead of running a bath. A shower generally uses less energy than a full bath.
- **Lead free:**
This product conforms to NSF/ANSI 372 for "lead free" plumbing products as defined by applicable US state laws and by section 1417 of the US Safe Drinking Water Act.

Overview of Controls and Indicators

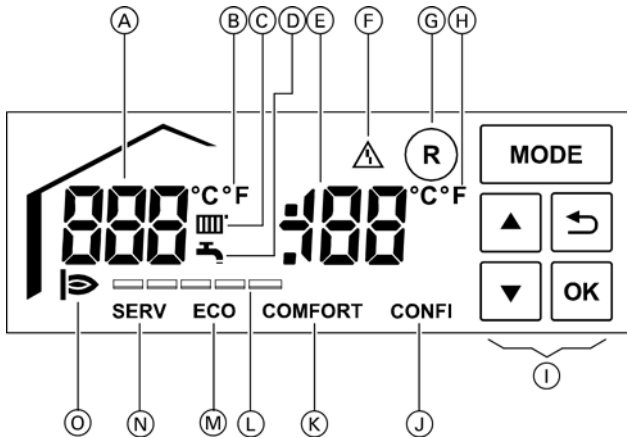

Legend

- (A) Display value or "F" (fault)
- (B) Temperature in °F/°C (in conjunction with the display value)
- (C) Heating mode
- (D) DHW heating
- (E) Display value or fault code
- (F) Fault indicator
- (G) Burner fault reset
- (H) Temperature in °F/°C (in conjunction with the display value)
- (I) On-screen buttons
- (J) Commissioning setting active (contractors only)
- (K) DHW comfort function active (only for B1KA)
- (L) Current burner output (each bar = 20% *)
- (M) DHW comfort function not active (only for B1KA)
- (N) Service setting active (contractors only)
- (O) Burner in operation

Display indicators and operating buttons

The control unit is equipped with a touchscreen. To make changes to settings and call up information, tap the on-screen buttons. Activation of the on-screen buttons is confirmed with a signal tone. Your heating contractor can turn the signal tone off, if desired.

On-screen buttons for operation

- MODE Selecting/terminating functions
- ▲ Changing or selecting values
- ▼ Changing or selecting values
- OK Accepting values/confirming selection
- ↶ 1 step back
- R Burner fault reset

Default display

The following is displayed:

- Current boiler water temperature
- Operating mode
- Burner operation and current burner output

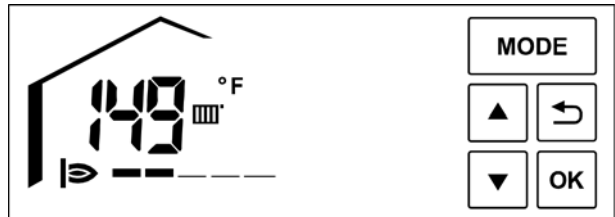

* Above diagram shows range of 40%

Your Local Viessmann Experts:
Francis Plumbing & Heating ClimateCare
 phone: 613-224-0041
 email: office@francisplumbing.com
 chat on our website: www.FrancisPlumbing.com

Operating Mode of the Heating System

Operation without room temperature thermostat

Setting the required heating water temperature, see page 10.

Operation with room temperature thermostat

Make any settings on the connected room temperature controller using the relevant operating instructions.

Note: Set the boiler water temperature high enough to achieve the required room temperature.

For boiler water temperature setting, see page 11

Weather-compensated operation without room temperature thermostat

In weather-compensated mode, the boiler water temperature is regulated subject to the outside temperature.

For setting the room temperature, see page 11.

Weather-compensated operation with room temperature thermostat

In weather-compensated mode, the boiler water temperature is regulated subject to the outside temperature.

Note: Connect a room thermostat to your heating system to prevent heat being generated unnecessarily at times when you do not require central heating. This enables central heating to be suspended at night, for example, in order to save energy.

For setting the room temperature, see page 11.

Starting the Heating System

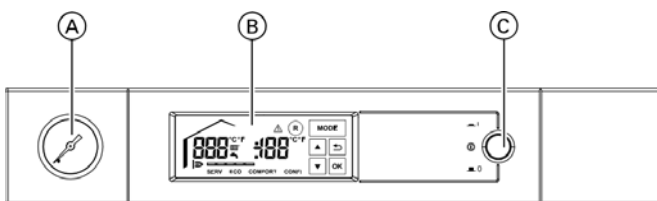

Legend

- (A) Pressure gage
- (B) LCD display unit
- (C) power switch ON/OFF

1. Check the pressure of your heating system on the pressure gauge.
Minimum system pressure 12 psi (0.8 bar)
Notify your heating contractor if the system pressure is too low.
2. In room air dependent operation:
Combustion air is drawn from the boiler room.
Check whether the vents in the boiler room are open and unobstructed.

- Open the gas shut-off valve.
 - Turn ON the ON/OFF switch.
- Your heating system and room temperature thermostat (if connected) are now ready for operation.

Shutting Down the Heating System

With frost protection monitoring



For additional information see page 12.

If you do not wish to use your boiler for several days you can stop central heating and/or DHW production. Set the boiler water temperature and the DHW temperature to OFF.

Frost protection monitoring is now active for the boiler and the DHW tank, see below for detailed instructions.

Note: Frost protection for the entire heating system
– see operating instructions for the room temperature controller.

Without frost protection (shutdown)

Shut down your heating system completely if it will not be needed for longer periods (several months).

We recommend you contact your local heating contractor if you are planning to take your heating system out of use for long periods. Your heating contractor can then take suitable steps such as frost protection for the system or heating surface preservation as required.

1. Close the gas shut-off valve and safeguard against unauthorized reopening.
2. Turn OFF the ON/OFF switch.

Note: The system is no longer protected against frost.

Stopping Central Heating and DHW Heating

Stopping central heating

You do not want to heat your home but you want to have DHW available (summer mode).

Tap the following on-screen buttons:

1. ▼ the set boiler water temperature flashes and is displayed.
2. ▼ until "OFF" is displayed.
3. OK to confirm.

Note: ■ The boiler circulation pump briefly starts every 24 hours to prevent it from seizing up.
■ Boiler frost protection is enabled.

Stopping DHW heating

You do not want to have DHW available.

Tap the following on-screen buttons:

1. MODE
2. ▼/▲ until flashes.
3. OK to confirm.
The set DHW temperature flashes.
4. ▼ until "OFF" is displayed.
5. OK to confirm.

Setting the Central Heating Temperature

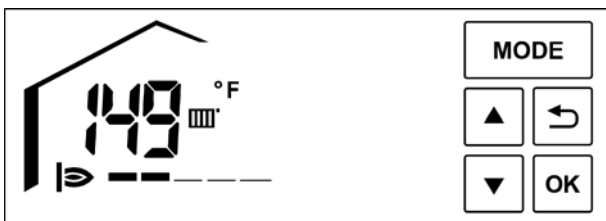

Display shows current boiler water temperature

Operation without room temperature thermostat

If no outside temperature sensor and no room temperature controller is connected, jumper must be installed on OT terminals.



Refer to the Installation and Service Instructions.

The room temperature is influenced by the heating water temperature. In the delivered condition, the heating water temperature is set to 158°F (70°C).

Setting the heating water temperature

Tap the following on-screen buttons:

1. ▼/▲ the set heating water temperature flashes and is displayed.
2. ▼/▲ until the required heating water temperature is displayed.
3. OK to confirm.

Setting the Central Heating Temperature *(continued)*

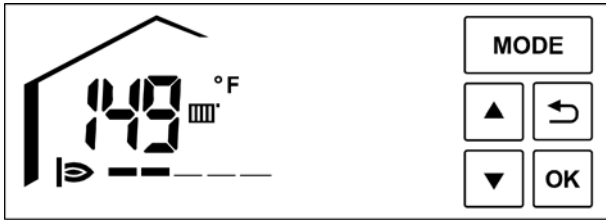

Display shows current boiler water temperature

Operation with room temperature thermostat

If no outside temperature sensor is connected, but a room temperature controller is. If the required room temperature is not achieved, ensure the boiler water temperature setting is sufficiently high. In the delivered condition, the boiler water temperature is set to 158°F (70°C).

Setting the boiler water temperature

Tap the following on-screen buttons:

1. ▼/▲ the set boiler water temperature flashes and is displayed.
2. ▼/▲ until the required boiler water temperature is displayed.
3. OK to confirm.



Left side of the display shows current boiler water temperature. Right side displays current outdoor temperature.

Weather-compensated operation without room temperature thermostat

Setting the room temperature

An outside temperature sensor must be connected for weather-compensated operation and a jumper must be installed on OT terminals.



Refer to the Installation and Service Instructions.

In the delivered condition, a parameter value of 20 (or 68 if display converted to °F) is set for central heating. Should you wish to set a higher room temperature, increase the parameter value; reduce it for a lower room temperature. Refer to 'setting the heating curve' on pages 12 and 13.

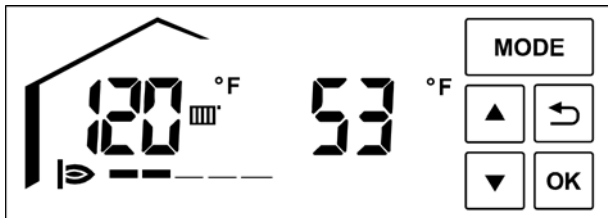

Left side of the display shows current boiler water temperature. Right side displays current outdoor temperature.

Weather-compensated operation with room temperature thermostat

Setting the room temperature

In the delivered condition, a parameter value of 20 (or 68 if display converted to °F) is set for central heating. Should you wish to set a higher room temperature, increase the parameter value; reduce it for a lower room temperature. Refer to 'setting the heating curve' on pages 12 and 13.

Call for heat on the room thermostat will activate the boiler. The boiler will operate based on the selected outdoor reset curve. When room thermostat is satisfied the boiler will shut down until the next call by the room thermostat.

Setting the Heating Curve

Heating curve

Heating curves illustrate the relationship between the outdoor temperature, the set room temperature and the boiler water temperature or supply temperature.

The lower the outdoor temperature, the higher the boiler water temperature or supply temperature.

In order to guarantee sufficient heat and minimum fuel consumption at any outdoor temperature, the conditions of your building and your heating system must be taken into consideration. The heating curve is set by your heating contractor for this purpose.

Frost protection function

The frost protection function requires an outside temperature sensor to be connected. The frost protection function becomes active at outside temperatures of $<41^{\circ}\text{F}$ ($<5^{\circ}\text{C}$). The burner starts and the boiler water temperature is held at 68°F (20°C).

Adjusting the Heating Curve

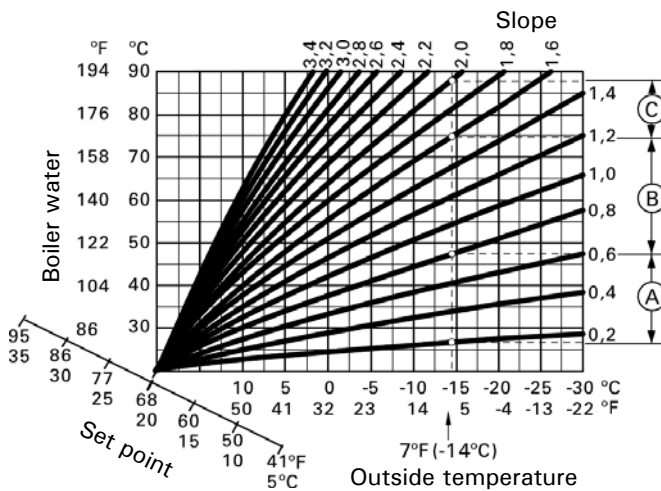

Example:

For outdoor temperature -14°C :

- (A) Underfloor heating system, slope 0.2 to 0.8
- (B) Low temperature heating system, slope 0.8 to 1.6
- (C) Heating system with a boiler water temperature in excess of 75°C , slope 1.6 to 2.0

1. Tap MODE.
2. Tap $\blacktriangledown/\blacktriangle$ until CONF1 flashes.
3. Tap OK to confirm. "P" is displayed in left hand display area. The right hand display area flashes. Enter 12 with $\blacktriangledown/\blacktriangle$.
4. OK to confirm. "1" flashes in left hand display area.
5. Use $\blacktriangledown/\blacktriangle$ to select "15".
6. OK to confirm. The right hand display flashes. Here, the heating curve slope can be adjusted. $\frac{12}{35}$ represents the heating curve 0.2, adjustable to $\frac{35}{35}$ (heating curve slope 3.5).
7. Tap $\blacktriangledown/\blacktriangle$ to select heating curve slope.
8. OK to confirm. The selected value is adopted.

Factory settings

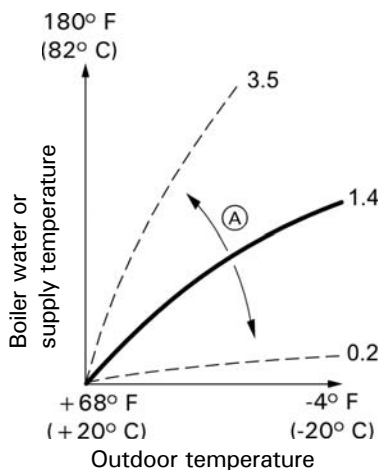

Slope = 1.4 and set point

Legend

- (A) Changing the slope: The gradient of the heating curves changes.

Adjusting the Heating Curve Set Point

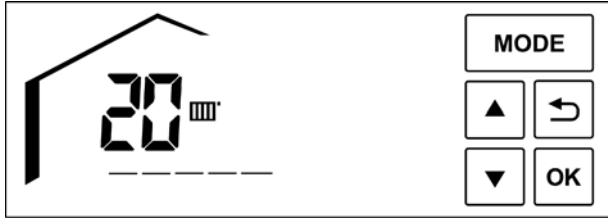

Heating curve set point

Parameter default setting is 20 (or 68 if display is converted to °F).

Setting the set point

1. Tap ▼/▲.
The set parameter flashes and  will be displayed.
2. Use ▼/▲ to select the parameter.
3. OK to confirm.

Note: When adjusting this setting, bear in mind that your heating system requires some time to heat the home to the required temperature.

Increasing set point temperature

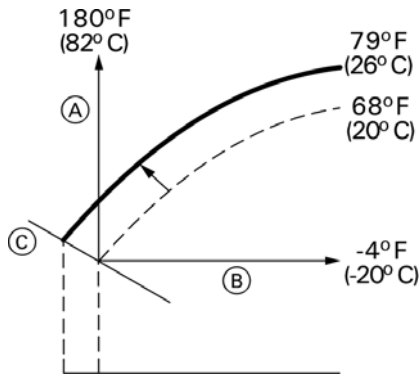

Adjustment of the increase set point temperature from 68 to 79°F (20 to 26°C)

Legend

- Ⓐ Boiler water temperature
- Ⓑ Outdoor temperature
- Ⓒ Set point

Reduced set point temperature

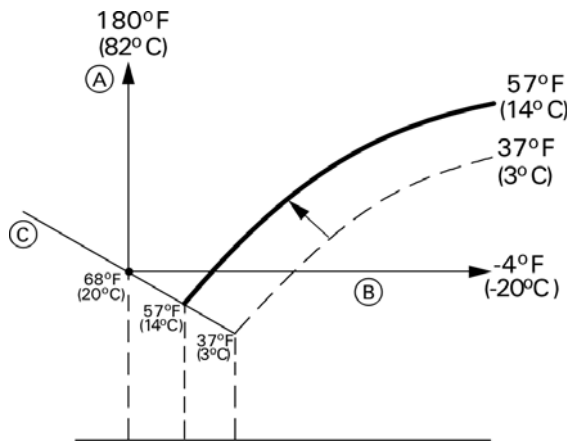

Adjustment of the reduced set point temperature from 37 to 52°F (3 to 14°C)

Legend

- Ⓐ Boiler water temperature
- Ⓑ Outdoor temperature
- Ⓒ Set point

DHW Temperature

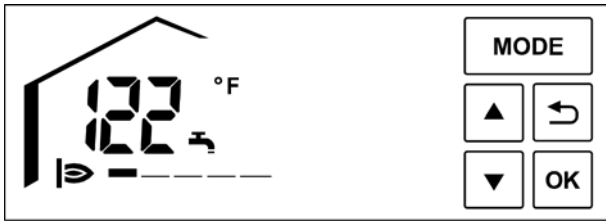

Tap the following on-screen buttons:

1. MODE
2. ▼/▲ until  flashes.
3. OK to confirm.
The set DHW temperature flashes.
4. ▼/▲ to set the required DHW temperature.
5. OK to confirm.

For the Vitodens 100-W B1KA with instantaneous DHW a scalding label is placed on the side of the boiler.

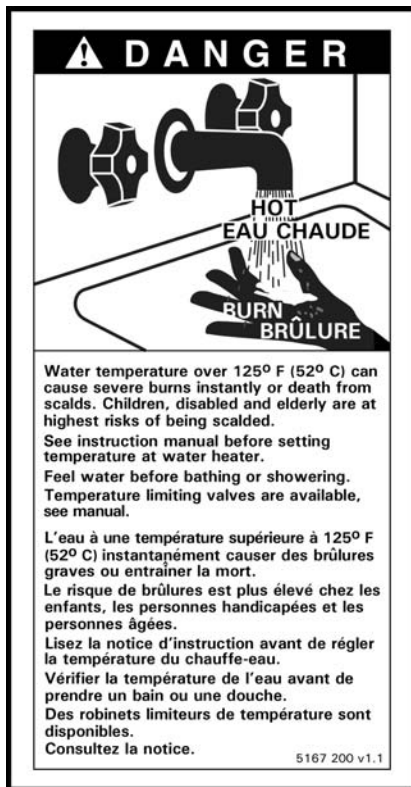





DHW comfort function

Only for Vitodens 100-W B1KA boiler.

Your heating contractor can activate the DHW comfort function. This makes DHW available faster when required. The display then shows "COMFORT".

Your Local Viessmann Experts:
Francis Plumbing & Heating ClimateCare
 phone: 613-224-0041
 email: office@francisplumbing.com
 chat on our website: www.FrancisPlumbing.com



Rooms are too Cold

Cause	Remedy
The heating system is off.	<ul style="list-style-type: none"> - Turn on the ON/OFF switch  (see illustration on page 9). - Switch ON the mains power switch, if installed (outside the boiler room). - Reset the circuit breaker in the power distribution board.
Control unit or remote control incorrectly adjusted.	<ul style="list-style-type: none"> - Operation with room temperature controller: Set a higher boiler water temperature (see page 11). - Weather-compensated operation: Set a higher room temperature (see page 11).
Only when operating with DHW heating: DHW priority is enabled ( is displayed)	Wait until the DHW tank has been heated up. In the case of operation with instantaneous domestic hot water (B1KA), stop DHW draw-off.
No fuel.	<p>With liquid propane gas: Check the fuel reserves and re-order if required.</p> <p>With natural gas: Open the gas shut-off valve. If necessary, check with your gas supply utility.</p>
 is shown on the display	Notify your heating contractor of the fault code shown.
 and the fault code flash on the display. The burner does not start.	<p>Reset burner fault (see page 17).</p> <p>Notify your heating contractor if the fault recurs.</p> <p>Danger: If faults are not rectified, they can have life threatening consequences. Do not reset the burner fault several times in quick succession. Notify your heating contractor if a fault recurs. Your heating contractor will be able to analyze the cause and rectify the fault.</p>
Air in the heating system	Bleed radiators.
The burner is switched off. Blockage in the ventilation air supply or flue system.	Notify your local heating contractor.

Rooms are too Hot

Cause	Remedy
Control unit or remote control is incorrectly adjusted.	<p>Check and correct the room temperature or boiler water temperature (see page 11)</p> <p>Refer to room temperature controller operating instructions</p>
 is shown on the display	Inform your heating contractor of the fault code.

There is no Hot Water

Cause	Remedy
The heating system is off.	<ul style="list-style-type: none"> - Turn on the ON/OFF switch  (see diagram on page 8). - Switch ON the mains power switch, if installed (outside the boiler room). - Reset the circuit breaker in the power distribution.
Control unit or remote control incorrectly adjusted.	Check settings and correct if required: <ul style="list-style-type: none"> - DHW heating must be enabled (see page 14).
No fuel.	With LPG: Check the fuel reserves and re-order if required. For natural gas: Open the gas shut-off valve. If necessary, check with your gas supply utility.
 is shown on the display	Notify your heating contractor of the fault code shown.
 and the fault code flash on the display. The burner does not start.	Reset burner fault (see page 17). Notify your heating contractor if the fault recurs. Danger: If faults are not rectified, they can have life threatening consequences. Do not reset the burner fault several times in quick succession. Notify your heating contractor if a fault recurs. Your heating contractor will be able to analyze the cause and rectify the fault.

The DHW is too Hot

Cause	Remedy
The control unit is incorrectly adjusted.	Check and correct the DHW temperature if required (see page 14).

and Fault Code Flashes on the Display

Cause	Remedy
The burner does not start.	Reset burner fault (see page 17). Notify your heating contractor if the fault recurs. Danger: If faults are not rectified, they can have life threatening consequences. Do not reset the burner fault several times in quick succession. Notify your heating contractor if a fault recurs. Your heating contractor will be able to analyze the cause and rectify the fault.

is Shown on the Display

Cause	Remedy
Heating system fault.	Inform your heating contractor of the fault code.

Fault Messages on the Display

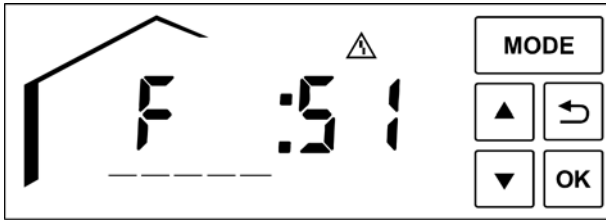

Any faults in your heating system are indicated on the display by a flashing fault symbol "  ". Read off the fault code in the display and report it to your heating contractor. This helps the contractor to properly prepare, and may result in lower service costs.

WARNING

Visually inspect the vent termination for any signs of blockage. Under cold climate conditions [sustained temperatures below 0° F (-18° C)] the vent termination may be severely blocked by icicle and frost build-up. The boiler control will automatically shut down the boiler should air intake or vent be blocked. Remove blockage if possible. Reset the boiler switch (ON / OFF switch to OFF and then back to ON) (see page 10) and the boiler should attempt to restart. If blockage is not obvious and cannot be removed, contact a licensed professional heating contractor.

Resetting a Burner Fault



Note: If  flashes and "R" appears on the display, the burner is locked out.

Press and hold "R" for approx. 2 seconds. If the fault no longer exists, the default display will appear. Notify your heating contractor if the fault recurs.

WARNING

If faults are not rectified, they can have life threatening consequences. Do not reset the burner fault several times in quick succession. Notify your heating contractor if a fault recurs. Your heating contractor will be able to analyze the cause and rectify the fault.

Your Local Viessmann Experts:
Francis Plumbing & Heating ClimateCare
 phone: 613-224-0041
 email: office@francisplumbing.com
 chat on our website: www.FrancisPlumbing.com

Cleaning

All appliances may be cleaned with a commercially available domestic cleaning agent (non-scouring).



Refer to the Installation and Service Instructions.

Inspection and Maintenance

Regular maintenance ensures trouble-free, energy efficient and environmentally responsible heating operation. For this, we strongly advise you to arrange an inspection and maintenance contract with your heating contractor.

Boiler

Increasing boiler contamination raises the flue gas temperature and thereby increases energy losses. All boilers should therefore be cleaned annually.

Terminology

Constant temperature operation

In constant temperature operation, the heating water is constantly (continuously) heated to the selected boiler water temperature.

Supply water temperature

The temperature of the heating water that flows to the radiators (roughly equal to boiler water temperature).

Boiler water temperature

The heating water in the boiler (boiler water) is heated to the temperature set at the control unit. This temperature is referred to as boiler water temperature.

Room air dependent operation

The combustion air is drawn from the room where the boiler is installed.

Direct vent operation

The combustion air is drawn from outside the building. The flue gases are vented outside the building.

Room temperature-dependent operation

A room temperature thermostat captures the room temperature and compares this with the required room temperature you set. If the room temperature is lower than the required value, the boiler is switched on; if the room temperature is higher than the required value, the boiler is switched off.

Make any settings on the connected room temperature controller using the relevant operating instructions.

Note: The heating water temperature must be set high enough in order to achieve the required room temperature.

Temperature and pressure relief valve

Safety equipment that must be installed in the hot water tank by your heating contractor. The safety valve opens automatically to prevent excess pressure in the DHW tank.

Drinking water filter (if installed)

A device that removes solids from potable water. The drinking water filter is installed in the cold water pipe upstream of the DHW tank or the instantaneous water heater.

For reasons of good hygiene:

- replace filter element on non-backwashing filters every 6 months (visual inspection every 2 months),
- on backwashing filters, backwash every 2 months.

Supply temperature

The temperature of the heating water that flows to the radiators (in the supply line). Accordingly, the temperature of the heating water that flows from the radiators to the boiler (in the return line) is referred to as return temperature.

Weather-compensated operation

In weather-compensated mode, the flow temperature is controlled according to the outside temperature. This means that no unnecessary heat is generated in order to heat the rooms to the required room temperature you selected.

The outside temperature is captured and transmitted to the control unit by a sensor fitted outside the building.



**FRANCIS PLUMBING & HEATING
CLIMATECARE.**

**Your Local Viessmann Experts:
Francis Plumbing & Heating ClimateCare
phone: 613-224-0041
email: office@francisplumbing.com
chat on our website: www.FrancisPlumbing.com**

Lighting and Operating Instructions

FOR YOUR SAFETY READ BEFORE OPERATING

W A R N I N G: If you do not follow these instructions exactly, a fire or explosion may result causing property damage, personal injury or loss of life.

- A. This appliance does not have a pilot. It is equipped with an ignition device which automatically lights the burner. Do not try to light the burner by hand.
- B. **BEFORE OPERATING** smell all around the appliance area for gas. Be sure to smell next to the floor because some gas is heavier than air and will settle on the floor.
WHAT TO DO IF YOU SMELL GAS
 - Do not try to light any appliance.
 - Do not touch any electric switch; do not use any phone in your building.
 - Immediately call your gas supplier from a neighbor's phone. Follow the gas supplier's instructions.
 - If you cannot reach your gas supplier, call the fire department.
- C. Use only your hand to push in or turn the gas control knob. Never use tools. If the knob will not push in or turn by hand, don't try to repair it, call a qualified service technician. Force or attempted repair may result in a fire or explosion.
- D. Do not use this appliance if any part has been under water. Immediately call a qualified service technician to inspect the appliance and to replace any part of the control system and any gas control which has been under water.

OPERATING INSTRUCTIONS

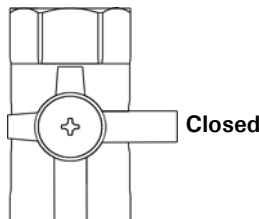
1. **STOP!** Read the safety information above on this label.
2. Set thermostat or other operating control to lowest setting.
3. Turn off all electric power to the appliance.
4. This appliance is equipped with an ignition device which automatically lights the burner. Do not try to light the burner by hand.
Manual gas shutoff

5. Close main gas shut-off valve.
6. Wait five (5) minutes to clear out any gas. Then smell for gas, including near the floor. If you smell gas, **STOP!** Follow "B" in the safety information above on this label. If you don't smell gas, go to the next step.
7. Open main gas shut-off valve.
8. Turn on all electric power to the appliance.
9. Set thermostat or other operating control to desired setting.
10. If the appliance will not operate, follow the instructions "To Turn Off Gas To Appliance" and call your service technician or gas supplier.

TO TURN OFF GAS TO APPLIANCE

1. Set thermostat or other operating control to lowest setting.
2. Turn off all electric power to the appliance if service is to be performed.
3. Close main gas shut-off valve.

Printed on environmentally friendly (recycled and recyclable) paper.

Technical information subject to change without notice.



Scan for digital copy of this document

Viessmann Manufacturing Company Inc.
 750 McMurray Road
 Waterloo, Ontario • N2V 2G5 • Canada
 TechInfo Line 1-888-484-8643
 1-800-387-7373 • Fax (519) 885-0887
 www.viessmann.ca • info@viessmann.ca

Viessmann Manufacturing Company (U.S.) Inc.
 45 Access Road
 Warwick, Rhode Island • 02886 • USA
 TechInfo Line 1-888-484-8643
 1-800-288-0667 • Fax (401) 732-0590
 www.viessmann-us.com • info@viessmann-us.com